



YAMAHA

PM-200B PA Mixer

SERVICE MANUAL

SPECIFICATIONS

CHANNELS	8
CHANNEL CONTROLS	Volume, Bass, Treble, Input Selector, Reverb/Echo, Reverb/Echo Selector
MASTER CONTROLS	Volume, Reverb/Echo, Acoustic Control, VU Meter Range Selector, Headphone Volume, Power Switch
FITTINGS	Input Jacks, Line Out Socket, Line Out Jack, Output Jacks (1, 2) w/Level Selector, To Echo/From Echo Jacks, Reverb Foot Switch Jack, Headphone Jack, VU Meter w/Pilot Lamp
FREQUENCY RESPONSE	± 0.4 dB; 20 ~ 20 kHz
TOTAL HARMONIC DISTORTION	$\leq 1\%$
CIRCUITRY	Solid State
POWER CONSUMPTION	10W
DIMENSIONS (W x D x H)	50.9 x 42.2 x 15.4cm (20 x 16½ x 6")
WEIGHT	10.5 kg (23.2 lbs.)

TERMINALS		NOMINAL LEVEL	IMPEDANCE
Input		-20, -40, -50dBm (78, 7.8, 2.4mVrms)	3k Ω (-50), 8k Ω (-40), 50k Ω (-20)
From Echo		-20dBm (78mVrms)	50k Ω
Out		-6, +4dBm (0.39, 1.23Vrms)	70 Ω
Line Out	Phone Type	-20dBm (78mVrms)	70 Ω
	Cannon Type XLR-3-32	-20dBm (78mVrms)	210 Ω (balanced)
To Echo		-30dBm (24mVrms)	5k Ω

Specifications subject to change without notice.

AMP UNIT REMOVAL

- (1) Set the unit up on its side and remove the four screws as shown in Figure 1.
- (2) Reset the unit in its normal position and remove the screw as shown in Figure 2.
- (3) Pull the amp unit forward to separate it from the wood case as shown in Figure 3.

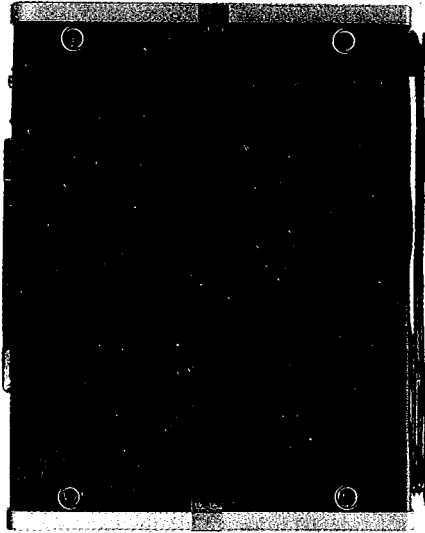

Figure 1

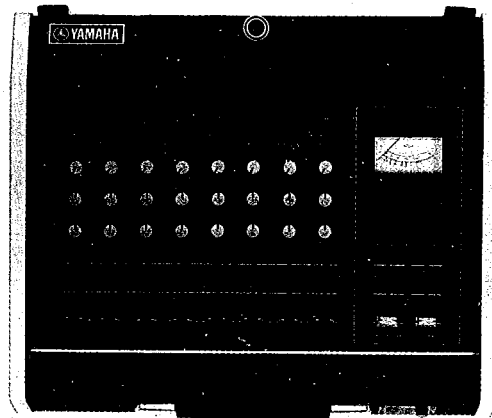

Figure 2

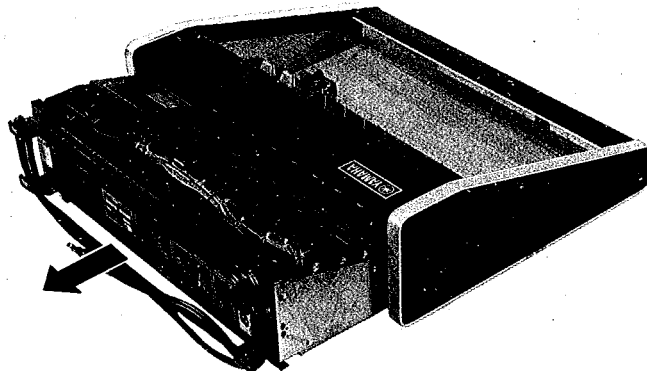

Figure 3

ELECTRICAL CHECKS AND ADJUSTMENTS

Equipment Requirements

- (1) The output impedance of the signal generator should be less than $1k\Omega$.
- (2) The input impedance of the oscilloscope, level meter, etc. should be more than $100k\Omega$.

Gain

- (1) Set up the various controls as shown in Table 1.

Volume	Maximum (CH1 ~ 8)
Bass, Treble	Center (CH1 ~ 8)
Reverb/Echo	Maximum (CH1 ~ 8)
Reverb/Echo Switch	Reverb
Master Volume	Maximum
Master Reverb/Echo	Minimum
Acoustic Control	0 (150 ~ 5000Hz)

Table 1

- (2) Connect a $10k\Omega$ dummy load to the Out jack.
- (3) Feed a $-60\text{dBm}/1\text{kHz}$ signal through the Input jack for that channel.
- (4) The output at the Out jack should be within the limits indicated in Table 2.

Input Level Switch Setting	Out Jack Level	
	Out Jack Level Switch: -6	Out Jack Level Switch: +4
-50	$-6 \pm 3 \text{ dBm}$	$+4 \pm 3 \text{ dBm}$
-40	$-16 \pm 3 \text{ dBm}$	$-6 \pm 3 \text{ dBm}$
-20	$-36 \pm 3 \text{ dBm}$	$-26 \pm 3 \text{ dBm}$

Table 2

Distortion

- (1) Set up the various controls as shown in Table 1, with the Out jack level switch to -6 and the input level switch to -50.
- (2) Feed a 1kHz signal through the Input jack for that channel. Set the input level so that the output at the Out jack is -6dBm .
- (3) The distortion factor should be within 1%.

Maximum Output

- (1) Set up the various controls as shown in Table 1, with the Out jack level switch to -6 and the input level switch to -50.
- (2) Feed a 1kHz signal through the Input jack for that channel. Set the input level at the point where the output waveform clips (distortion factor: 3%).
- (3) The output at the Out jack should be more than $+11\text{dBm}$.

VU Meter

- (1) Set the various controls as shown in Table 1, with the input level switch to -50.
- (2) Feed a 1kHz signal through the Input jack.
- (3) The VU meter should indicate the value given in Table 3.

Out Jack Level Switch Setting	Meter Range Switch Setting	Out Jack Level	VU Meter Indication
-6	Normal	-6dBm	$+3 \pm 0.5 \text{ VU}$
+4	Normal	$+4\text{dBm}$	$0 \pm 1.5 \text{ VU}$
-6	Low	-19dBm	$0 \pm 1.5 \text{ VU}$

Table 3

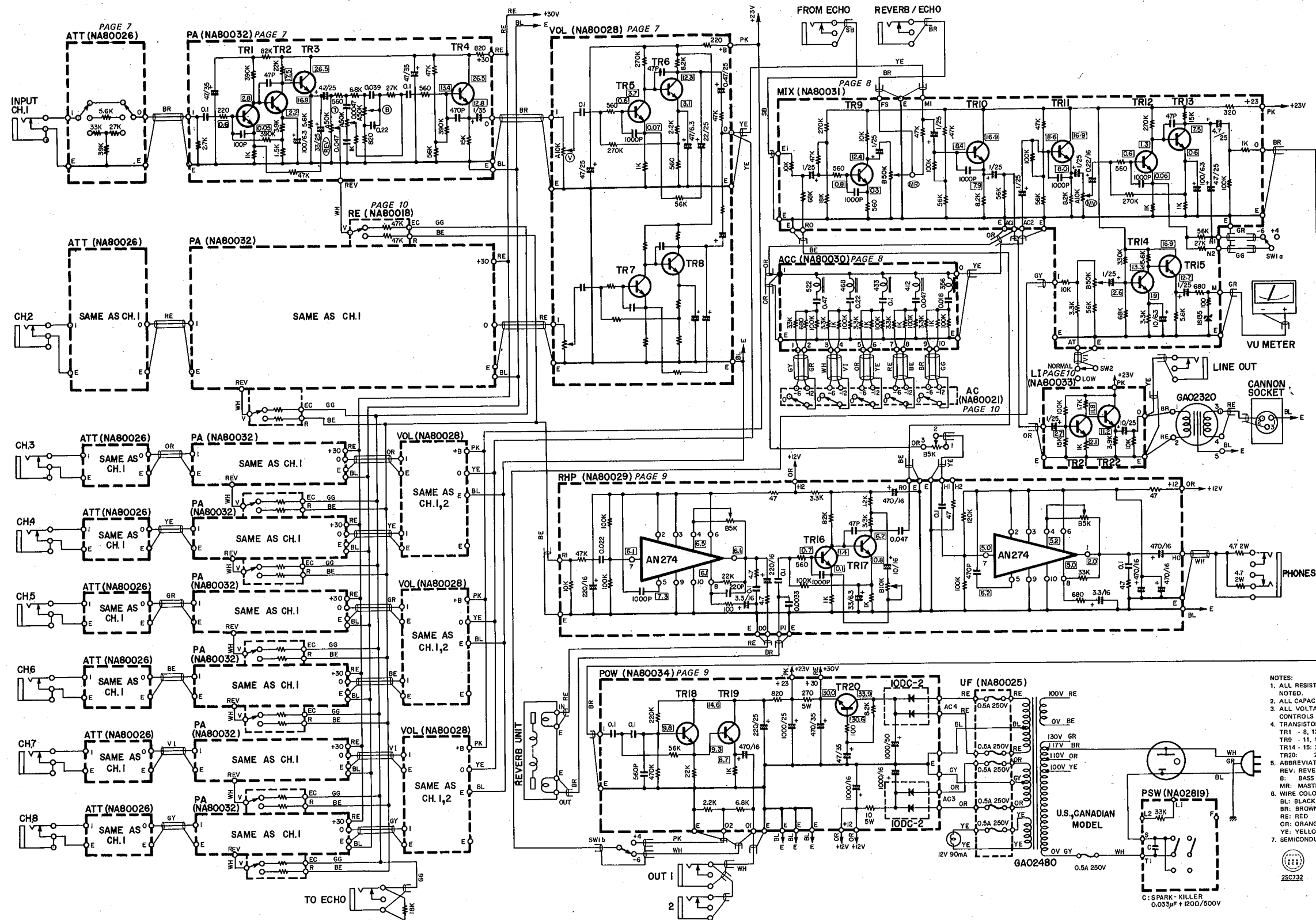

PM-200B PA MIXER SCHEMATIC DIAGRAM

▼FOR GENERAL MODEL

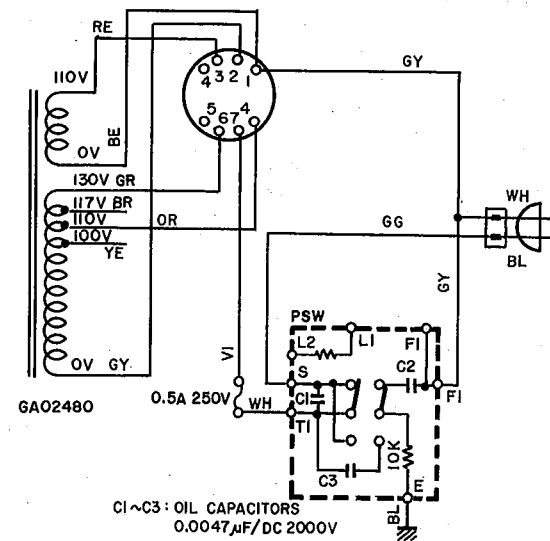

▼FOR EUROPEAN MODEL

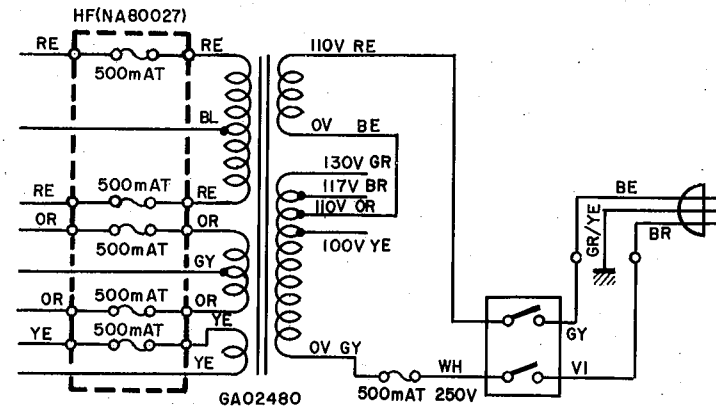

▼FOR U.S., CANADIAN MODEL

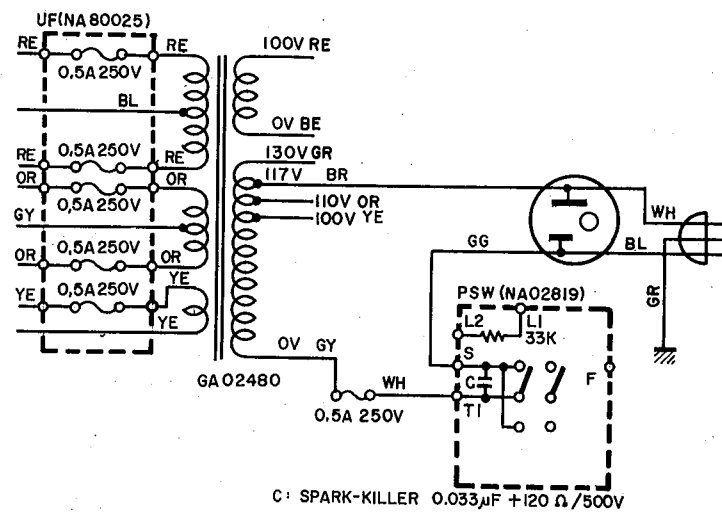

▼FOR SOUTH AFRICAN MODEL

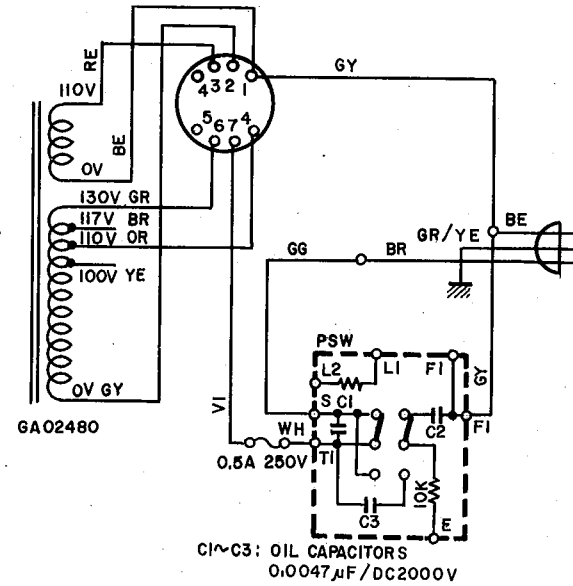

▼FOR AUSTRALIAN MODEL

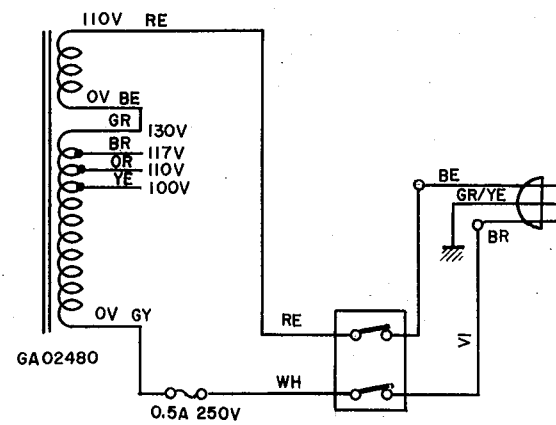

POWER CIRCUIT ARRANGEMENTS

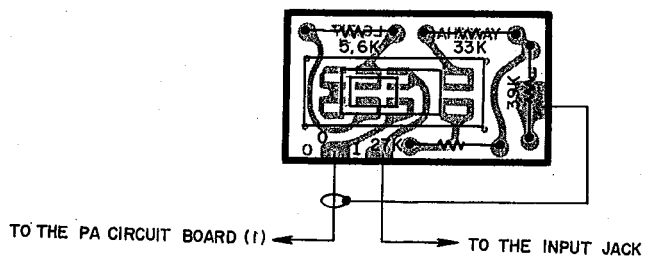

Part No.	Description
NA80026	ATT Circuit Board Ass'y #1317-1
KA40007	Slide Switch

ATT CIRCUIT BOARD

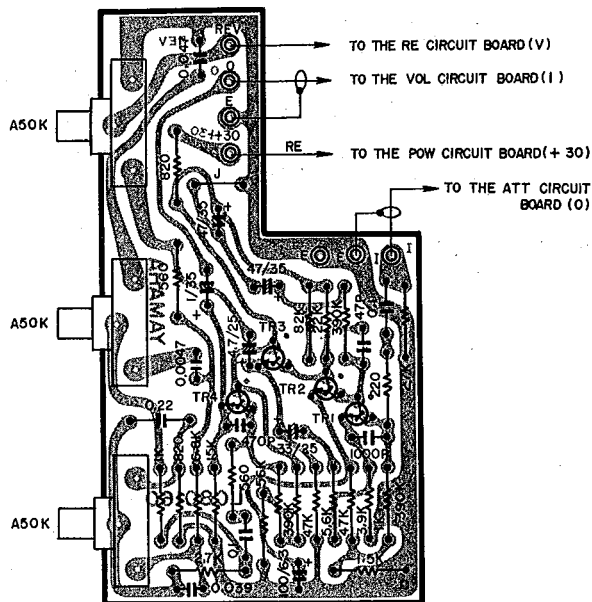

Part No.	Description
NA80032	PA Circuit Board Ass'y #80160
IC07324	Transistor 2SC732
HS32005	Variable Resistor A50kΩ
FP15610	Tantalum Capacitor 1μF/35V

PA CIRCUIT BOARD

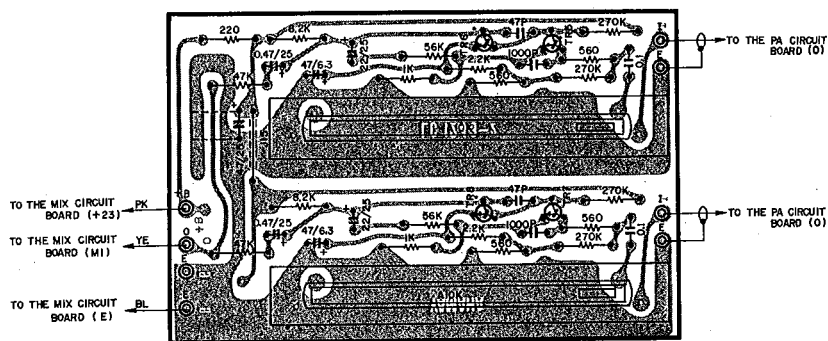

Part No.	Description
NA80028	VOL Circuit Board Ass'y #1243-2
IC07324	Transistor 2SC732
HQ20017	Variable Resistor A10kΩ (Slide Type)

VOL CIRCUIT BOARD

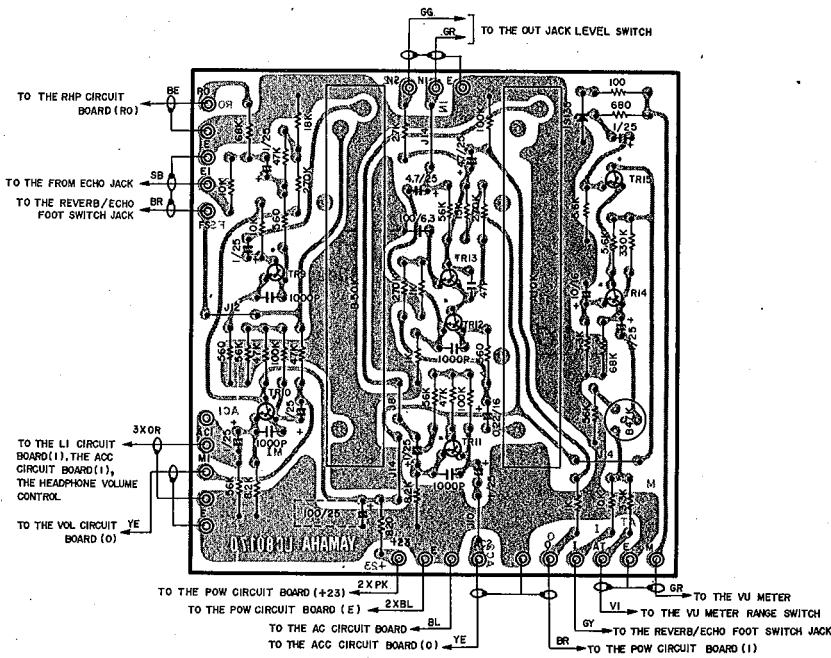

Part No.	Description
NA80031	MIX Circuit Board Ass'y #80170
IC07324	Transistor 2SC732
IC06443	Transistor 2SC644
IC08282	Transistor 2SC828
IF00013	Zener Diode 1S135
HQ20017	Variable Resistor A10kΩ (Slide Type)
HQ20018	Variable Resistor B50kΩ (Slide Type)
HT41014	Variable Resistor B47kΩ

MIX CIRCUIT BOARD

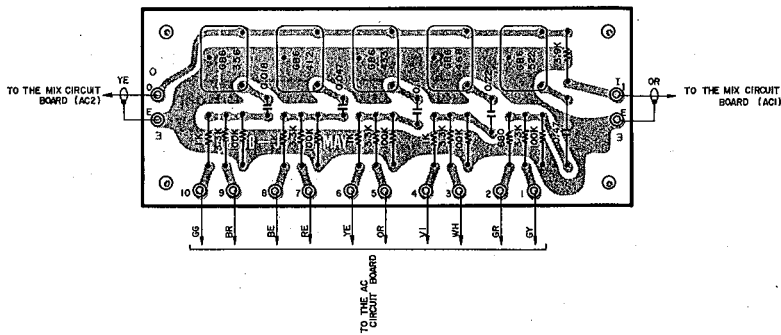

Part No.	Description
NA80030	ACC Circuit Board Ass'y #80190
GB06522	Filter Coil
GB06468	Filter Coil
GB06433	Filter Coil
GB06412	Filter Coil
GB06356	Filter Coil

ACC CIRCUIT BOARD

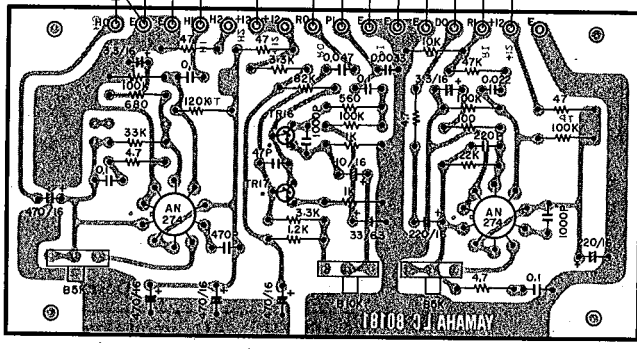
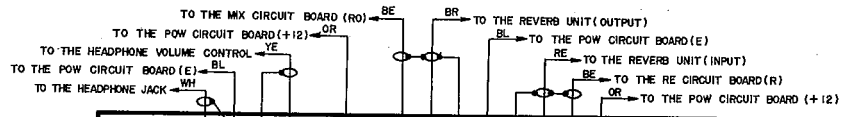

Part No.	Description
NA80029	RHP Circuit Board Ass'y #80181
IC06443	Transistor 2SC644
BA00512	Heat-sinker
IG00004	Integrated Circuit AN274
FP13633	Tantalum Capacitor 3.3μF/16V
HT14018	Variable Resistor B5kΩ
HT14019	Variable Resistor B10kΩ

RHP CIRCUIT BOARD

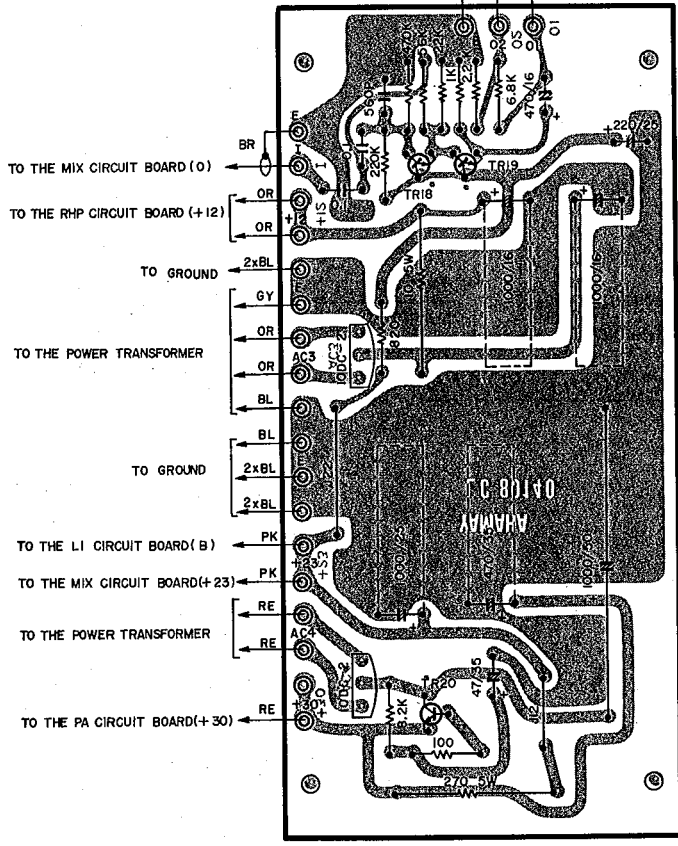

Part No.	Description
NA80034	POW Circuit Board Ass'y #80140
IC07324	Transistor 2SC732
IC04854	Transistor 2SC485
BA00512	Heat-sinker
IH00005	Diode 10DC-2
HM55527	Cement Molded Resistor 270Ω 5W
HM55410	Cement Molded Resistor 10Ω 5W

POW CIRCUIT BOARD

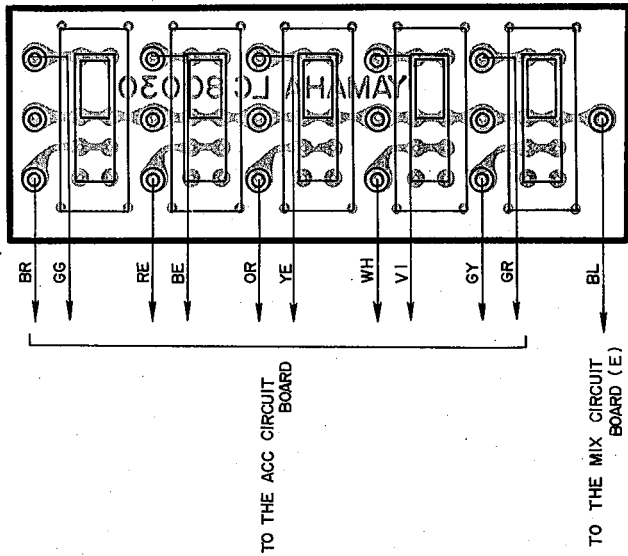

Part No.	Description
NA80021	AC Circuit Board Ass'y #80030
KA40008	Slide Switch

AC CIRCUIT BOARD

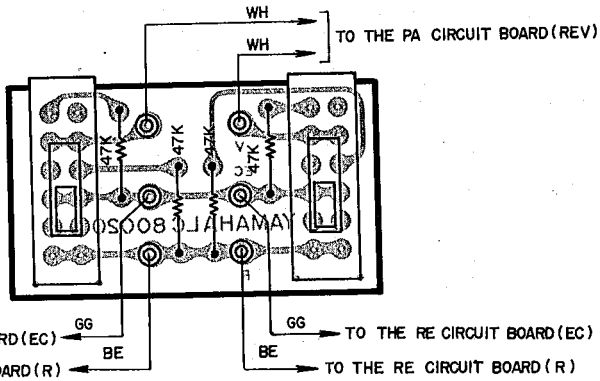

Part No.	Description
NA80018	RE Circuit Board Ass'y #80020
KA40022	Slide Switch

RE CIRCUIT BOARD

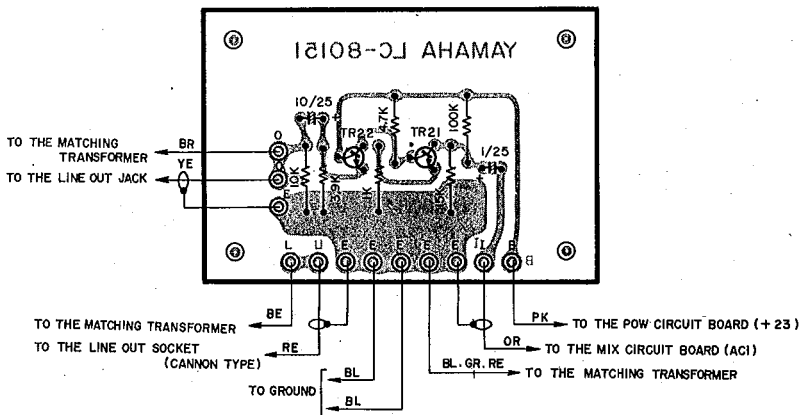

Part No.	Description
NA80033	LI Circuit Board Ass'y #80151
IC07324	Transistor 2SC732

LI CIRCUIT BOARD

PARTS LIST

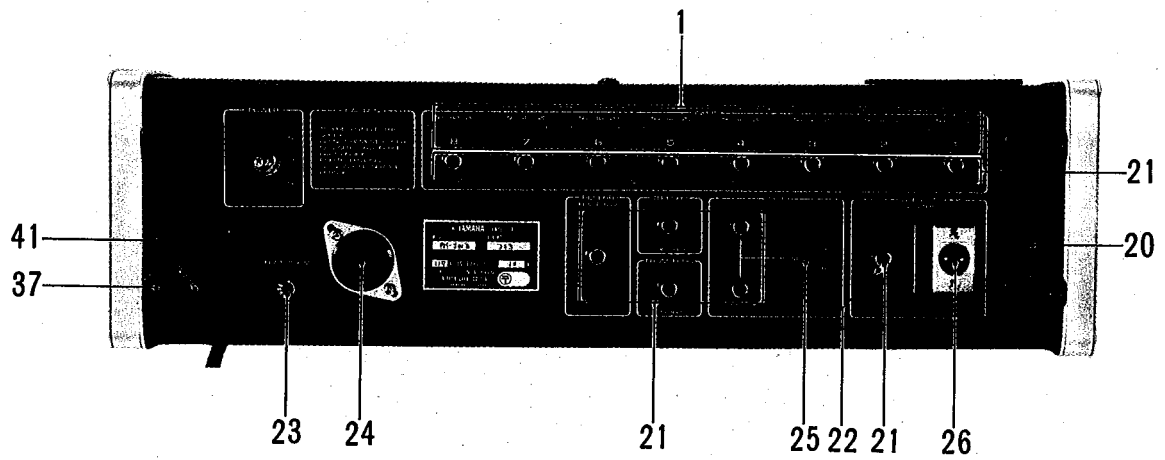
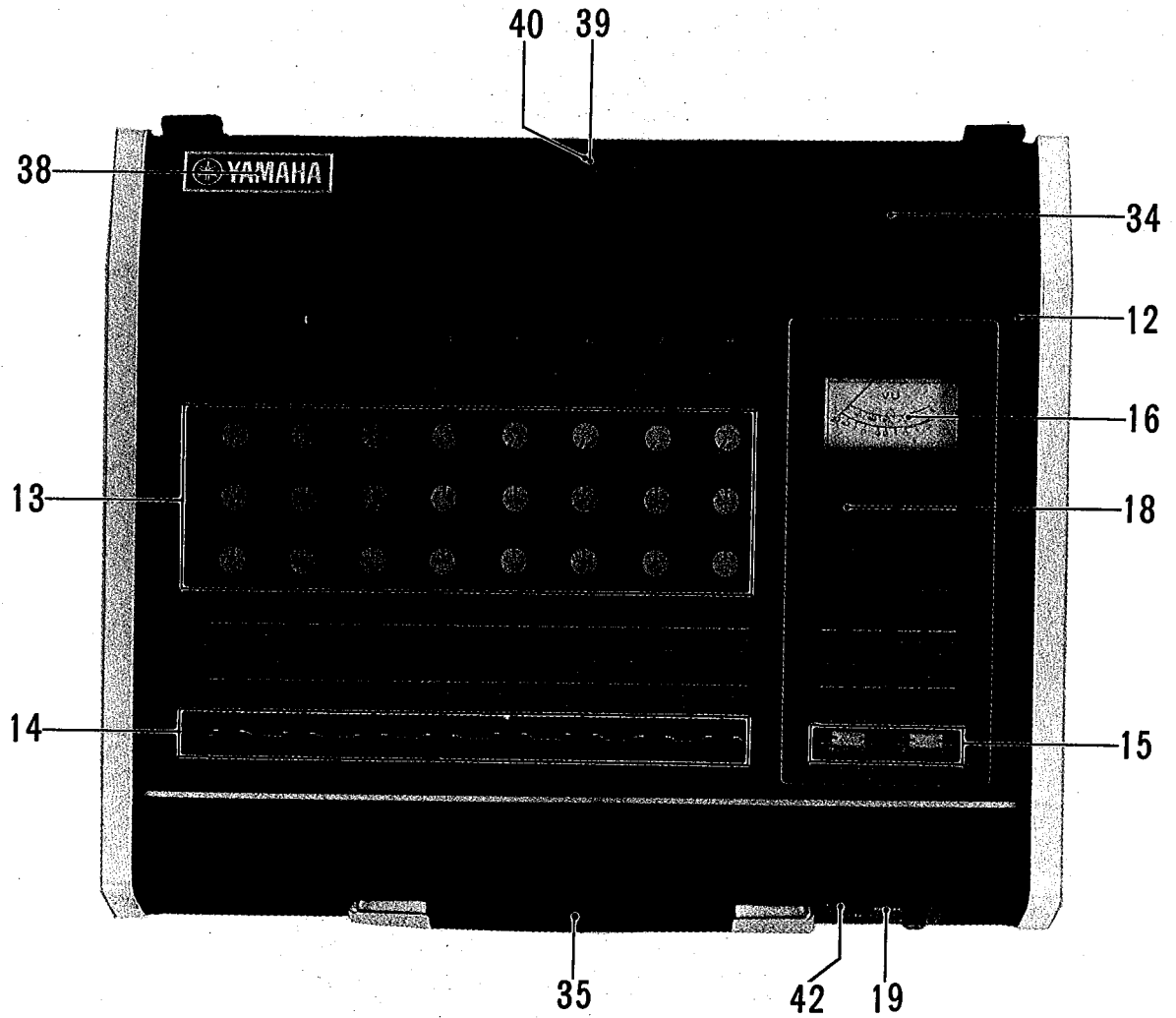

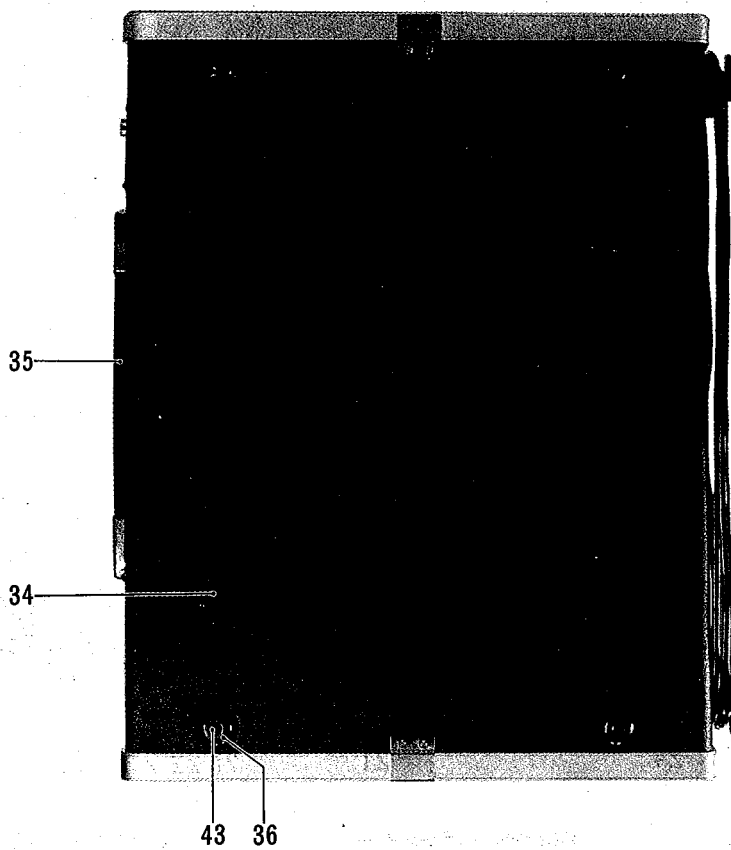
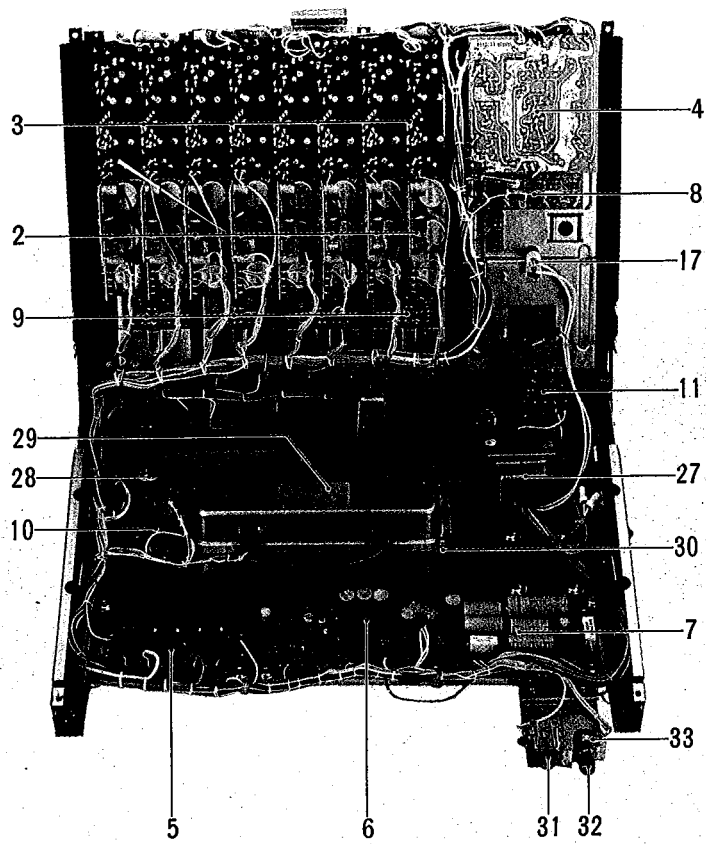

Ref. No.	Part No.	Description		Remarks	Common Models
1	NA80026	ATT circuit board	#1317-1	A T T シ ー ト	
2	NA80032	PA circuit board	#80160	P A シ ー ト	
3	NA80028	VOL circuit board	#1243-2	V O L シ ー ト	
4	NA80031	MIX circuit board	#80170	M I X シ ー ト	
5	NA80030	ACC circuit board	#80190	A C C シ ー ト	
6	NA80029	RHP circuit board	#80181	R H P シ ー ト	
7	NA80034	POW circuit board	#80140	P O W シ ー ト	
8	NA80021	AC circuit board	#80030	A C シ ー ト	
9	NA80018	RE circuit board	#80020	R E シ ー ト	
10	NA80033	LI circuit board	#80151	L I シ ー ト	
	NA80025	UF (fuse) circuit board	#80101	U F シ ー ト	U.S., Canadian model only
	NA80027	HF (fuse) circuit board	#80101	H F シ ー ト	European model only
11	NA02482	PSW circuit board	#1185-2	P S W シ ー ト	General, South African model (110 ~ 130V area)
11	NA02483	PSW circuit board	#1185-2	P S W シ ー ト	General, South African model (220 ~ 240V area)
11	NA02819	PSW circuit board	#15681	P S W シ ー ト	U.S., Canadian model only
11	KA30001	Power switch		トグルスイッチ	European, Australian model only
12		Control panel ass'y		パネル Ass'y	
13	CB02316	Knob, gray		ツマミ (ブルーグレー)	
14	CB02323	Knob, black		ツマミ (ブラック)	
15	CB02324	Knob, orange		ツマミ (オレンジ)	
16	J100030	VU meter		レベルメータ	
17	LB20013	Lamp socket		パイロットソケット	
	JB00011	Lamp 12V 90mA		ランプ	
18	KA40016	Slide switch		スライドスイッチ	
19	AA02516	Panel (S)		パネル (S)	
20	AA80062	Rear panel		バックパネル	
21	LB20063	Phone jack		イヤホンジャック	
22	CB06201	Phone nut		ホンナット	
23	LB20048	Fuse holder		ヒューズホルダー	except for European model
23	LB20059	Fuse holder		ヒューズホルダー	European model only
	KB00031	Fuse	0.5A 250V	ヒューズ	except for European model
	KB00071	Miniature fuse	0.5AT 250V	ミニヒューズ	European model only
24	LB30025	AC socket		3P ACソケット	U.S., Canadian model only
	LB20030	AC socket		ACソケット	General model only
	LB20025	Voltage selector		電圧切換器	General, South African model only
25	KA40025	Slide switch		スライドスイッチ	
26	LB30016	Cannon socket, XLR-3-32		キャノンソケット	
27	GA02480	Power transformer		電源トランス	
28	GA02320	Matching transformer		マッチングトランス	
29	JH00007	Reverb unit		リバーブユニット	
30	CB80059	Rubber bush		ゴムブッシュ	
31	LB30006	Phone jack		イヤホンジャック	
32	BA06250	Knob		ツマミ	
33	HS31001	Variable resistor	B50k Ω x 2	可変抵抗	

